

UMEL-60043

Melbourne 5 Flush In-Ground

Construction

Housing

The luminaire housing is constructed from durable steel for long-term performance, with Trim and top sections made from Marine Grade 316 stainless steel for superior corrosion resistance

Memory Retentive - Silicon Gasket

Equipped with a specially designed injection-molded, high-temperature, memory-retentive silicone gasket. This ensures long life and maintains the gasket's exact profile and seal over years of use and compression.

Thermal Management

LM6 aluminum is utilized for its exceptional mechanical strength and thermal dissipation properties in both low and high ambient temperatures. Ligman's advanced thermal heat sink, working in conjunction with the LED driver, keeps all components within optimal temperature ranges. This design guarantees extended LED life with less than 10% lumen depreciation at 50,000 hours.

Surge Suppression

Each fixture includes a standard 10kV surge suppressor for reliable protection.

BUG Rating

Contact Factory

Hardware

Provided Hardware is Marine grade 316 Stainless steel.

Anti Seize Screw Holes

Tapped holes are treated with a special anti-seize compound to prevent thread seizure caused by electrolysis, heat, corrosive atmospheres, and moisture.

Crystal Clear Low Iron Glass Lens

Provided with tempered, impact resistant crystal clear low iron glass ensuring no green glass tinge.

Optics & LED

Precise optic design provides exceptional light control and precise distribution of light. LED CRI > 80

Lumen - Maintenance Life

L80/B10 at 50,000 hours (meaning at least 90% of LEDs maintain 80% of their original flux).

Discreet, Submersible In-Ground

A premium family of in-ground uplights featuring a round profile and flush-mounted frame. Available in a variety of beam angles and lumen outputs, with corresponding housing sizes, adjustable optics, and RGBW options for complete creative control.

The fixture is manufactured with a Marine Grade 316 stainless steel front ring and is designed for illuminating building facades, columns, squares, parks, gardens, sculptures, flagpoles, and trees. Its IP68 rating allows installation in depths of up to 5 feet. Adjustable high-powered LEDs combined with high-efficiency optics deliver precise beam distributions to suit any design application. RGBW options provide complete creative freedom for dynamic lighting effects.

The high-density polyethylene in-ground recessing box includes securing lugs on each side to ensure stability during concrete pour. The housing features two shoulders to prevent fixture rotation in drive-over applications. Clear tempered glass, 0.6" thick, supports a maximum load of 5.5 tons, transferring weight to the foundation. Vehicles with pneumatic tires can safely drive over the luminaire at speeds up to 30 mph.

The Melbourne model offers an optional non-slip ADA glass, infused with a specialized coating across the entire lens surface—making it the best non-slip option in the industry.

To ensure longevity, provide efficient drainage by placing gravel to a depth of 17 inches and a width of 12 inches beneath and around the housing. An animated installation video is available on the Ligman website to assist contractors and ensure a problem-free installation.

30w LED (2802 - 2950) Lumens
IP68 · Suitable For Wet Locations
IK10 · Impact Resistant (Vandal Resistant)
Weight 37.5 lbs

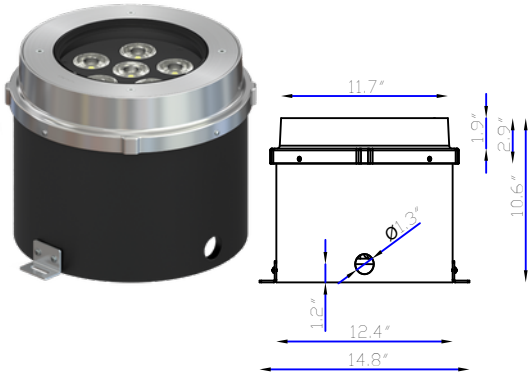
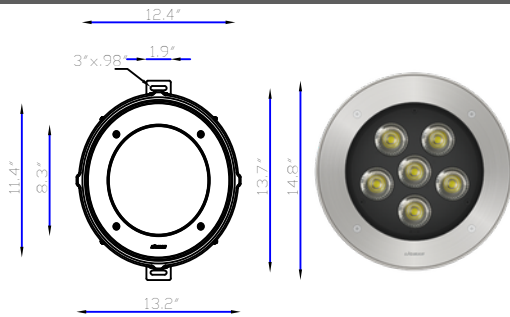

Additional Options (Consult Factory For Pricing)

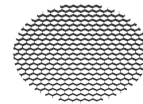

A62521
Honeycomb Louvre



A62212
Anti-Slip Glass



A614491
Glass Suction Cup



UMEL-60043

Melbourne 5 Flush In-Ground

PROJECT		DATE	
---------	--	------	--

QUANTITY		TYPE		NOTE	
----------	--	------	--	------	--

ORDERING EXAMPLE || UMEL-60043 - 30w - VN - W30

UMEL-60043			
LAMP	BEAM	LED COLOR	
30w LED (2802 - 2950) Lumens	VN - Very Narrow Beam 8°	W27 - 2700K W30 - 3000K W35 - 3500K W40 - 4000K	

--	--	--	--	--	--

ADDITIONAL OPTIONS

- A62521 - Honeycomb Louvre
- A62212 - Anti-Slip Glass
- A614491 - Glass Suction Cup
- DIM - 0-10v Dimming Components

