

UVA-10073

Vancouver 37 Bollard

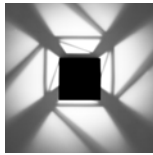

Shadow Effect



Construction

Aluminum

Less than 0.1% copper content – Marine Grade 6060 extruded & LM6 Aluminum High Pressure die casting provides excellent mechanical strength, clean detailed product lines and excellent heat dissipation.

Pre paint

8 step degraese and phosphate process that includes deoxidizing and etching as well as a zinc and nickel phosphate process before product painting.

Memory Retentive -Silicon Gasket

Provided with special injection molded "fit for purpose" long life high temperature memory retentive silicon gaskets. Maintains the gaskets exact profile and seal over years of use and compression.

Thermal management

LM6 Aluminum is used for its excellent mechanical strength and thermal dissipation properties in low and high ambient temperatures. The superior thermal heat sink design by Ligman used in conjunction with the driver, controls thermals below critical temperature range to ensure maximum luminous flux output, as well as providing long LED service life and ensuring less than 10% lumen depreciation at 50,000 hours.

Surge Suppression

Standard 10kv surge suppressor provided with all fixtures.

BUG Rating

B1 - U1 - G0

Finishing

All Ligman products go through an extensive finishing process that includes fettling to improve paint adherence.

Paint

UV Stabilized 4.9Mil thick powder coat paint and baked at 200° C. This process ensures that Ligman products can withstand harsh environments. Rated for use in natatoriums.

Inspired by Nature Finishes

The Inspired by nature Finishing is a unique system of decorative powder coating. Our metal decoration process can easily transform the appearance of metal or aluminum product into a wood grain finish.

This patented technology enables the simulation of wood grain, and even marble or granite finish through the use of decorative powder coating.

The wood grain finish is so realistic that it's almost undistinguishable from real wood, even from a close visual inspection. The system of coating permeates the entire thickness of the coat and as a result, the coating cannot be removed by normal rubbing, chipping, or scratching.

The Coating Process

After pre-treatment the prepared parts are powder coated with a specially formulated polyurethane powder. This powder provides protection against wear, abrasion, impact and corrosion and acts as the relief base color for the finalized metal decoration.

The component is then wrapped with a sheet of non-porous film with the selected decoration pattern printed on it using special high temperature inks.

This printed film transfer is vacuum-sealed to the surface for a complete thermo print and then transferred into a customized oven. The oven transforms the ink into different forms within the paint layer before it becomes solid. Finally, the film is removed, and a vivid timber look on aluminum remains.

Wood grain coating can create beautiful wood-looking products of any sort. There are over 300 combinations of designs currently in use. Wood grains can be made with different colors, designs, etc.

Our powder coatings are certified for indoor and outdoor applications and are backed by a comprehensive warranty. These coatings rise to the highest conceivable standard of performance excellence and design innovation.

Added Benefits

- Resistance to salt-acid room, accelerated aging
- Boiling water, lime and condensed water resistant
- Anti-Graffiti, Anti-Slip, Anti-Microbial, Anti-Scratch
- Super durable (UV resistant)
- TGIC free (non-toxic)

Hardware

Provided Hardware is Marine grade 316 Stainless steel.

Anti Seize Screw Holes

Tapped holes are infused with a special anti seize compound designed to prevent seizure of threaded connections, due to electrolysis from heat, corrosive atmospheres and moisture.

Crystal Clear Low Iron Glass Lens

Provided with tempered, impact resistant crystal clear low iron glass ensuring no green glass tinge.

Optics & LED

Precise optic design provides exceptional light control and precise distribution of light.
LED CRI > 80

Lumen - Maintenance Life

L80 /B10 at 50,000 hours (This means that at least 90% of the LED still achieve 80% of their original flux)

Contemporary urban lighting furniture. Open-sided, three lattice pattern options or your bespoke design.

A stylish Dark Sky Compliant square high performance bollard with downward light distribution using LED lamps. This light column offers optimal visual comfort through glare control by utilizing a controlled optics designed by Ligman. These bollards have a square design providing a unique wide light distribution, offering an architecturally appealing clover leaf pattern on the paving. The internal sides of the supporting pillars are accented by light from the LED.

Color temperature 2700K, 3000K, 3500K and 4000K. The minimalistic shape provides distinctive lighting effects by night and decorative urban effect during the day. Suitable for pedestrian areas, precincts, building surrounds, shopping centers, squares and parks. The Vancouver Bollard comes standard with a unique waterproof internal driver housing compartment that is situated at the top of the pole to stop water and dust from entering the electrical components. This fixture is supplied completely wired with powercord and waterproof gland from the driver enclosure to the base of the column to ensure quick trouble-free installation.

The Vancouver has a specially designed anchor bolt mounting base that is partially buried below ground level to provide a flush fixture finish with the surface, but maintains the rigidity that is required when installing bollards.

Custom bollard heights are available, please specify. Provided with anchor bolts Reduced custom wattages can be provided to suit customer requirements. (Specify total watt requirement per fixture) Designed to complement the Vancouver Light Column UVA-20001

• **NOTE: For the round version of the Vancouver, please see the Benton Light Column and Bollard**

21w COB 1571 Lumens

IP65 • Suitable For Wet Locations

IK08 • Impact Resistant (Vandal Resistant)

Weight 34.8 lbs

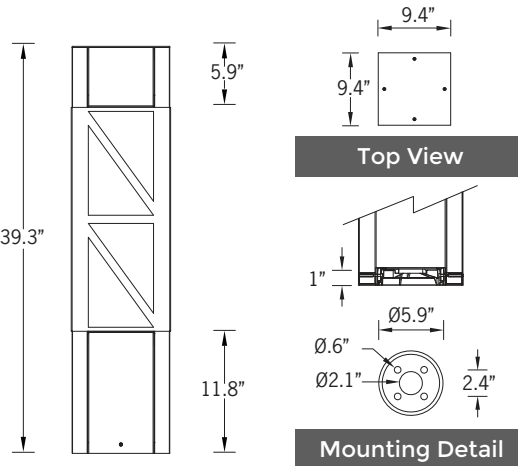

UVA-10073

Vancouver 37 Bollard

PROJECT		DATE	
----------------	--	-------------	--

QUANTITY		TYPE		NOTE	
-----------------	--	-------------	--	-------------	--

ORDERING EXAMPLE || UVA - 10073 - 21w - W30 - 02 - 120/277v - Options

UVA-10073				
LAMP	LED COLOR	FINISH COLOR	VOLTAGE	
21w COB 1571 Lumens	W27 - 2700K W30 - 3000K W35 - 3500K W40 - 4000K	01 - BLACK RAL 9011 02 - DARK GREY RAL 7043 03 - WHITE RAL 9003 04 - METALLIC SILVER RAL 9006 05 - MATTE SILVER RAL 9006 06 - LIGMAN BRONZE 07 - CUSTOM RAL	120/277v Other - Specify	

INSPIRED BY NATURE FINISHES

SW01 - OAK FINISH	
SW02 - WALNUT FINISH	
SW03- PINE FINISH	
DF - DOUGLAS FIR FINISH	
CW - CHERRY WOOD FINISH	
NW - NATIONAL WALNUT FINISH	
SU01 - CONCRETE FINISH	
SU02 - SOFTSCAPE FINISH	
SU03 - STONE FINISH	
SU04 - CORTEN FINISH	

THERE IS AN ADDITIONAL COST FOR THESE FINISHES

--	--	--

ADDITIONAL OPTIONS

- NAT - Natatorium Rated
- HGT - Custom Bollard Height
- DIM - 0-10v Dimming
- GFCI - GFCI Box

More Custom Finishes Available Upon Request

Consult factory for pricing and lead times

Oak	Cherry	Beech	Carbon
Walnut	Chestnut	Bamboo	Galvanized
Pine	Mahogany	Birch	Steel



Vancouver Product Family

Vancouver 1
 • UVA-20001-40w-2969lm [9.4'x9.4"-14.7']

Vancouver 2
 • UVA-20011-20w-1414lm [6.3'x6.3"-9.8']

Vancouver 3
 • UVA-10001-21w-1270lm [9.4'x9.4"-39.3']

Vancouver 4
 • UVA-10011-15w-837lm [6.3'x6.3"-39.3']

Vancouver 5
 • UVA-20021-39/21w-1336/1673lm [9.4'x9.4"-13.3']
 • UVA-20022-39/2x21w-1336/2x1673lm [9.4'x9.4"-14.5']
 • UVA-20023-39/3x21w-1336/3x1673lm [9.4'x9.4"-15.7']

Vancouver 6
 • UVA-20031-39/21w-1167/1673lm [9.4'x9.4"-13.3']
 • UVA-20032-39/2x21w-1167/2x1673lm [9.4'x9.4"-14.5']
 • UVA-20033-39/3x21w-1167/3x1673lm [9.4'x9.4"-15.7']

Vancouver 7
 • UVA-20041-39/21w-1670/1673lm [9.4'x9.4"-13.3']
 • UVA-20042-39/2x21w-1670/2x1673lm [9.4'x9.4"-14.5']
 • UVA-20043-39/3x21w-1670/3x1673lm [9.4'x9.4"-15.7']

Vancouver 8
 • UVA-20051-40w-1336lm [9.4'x9.4"-12.1']

Vancouver 9
 • UVA-20061-40w-1167lm [9.4'x9.4"-12.1']

Vancouver 10
 • UVA-20071-40w-1670lm [9.4'x9.4"-12.1']

Vancouver 11
 • UVA-10021-21w-570lm [9.4'x9.4"-39.3']

Vancouver 12
 • UVA-10031-21w-490lm [9.4'x9.4"-39.3']

Vancouver 13
 • UVA-10041-21w-704lm [9.4'x9.4"-39.3']

Vancouver 14
 • UVA-70001-8w-331lm [6.3'x6.3"-15.7']

Vancouver 15
 • UVA-70011-21w-815lm [9.4'x9.4"-15.7']

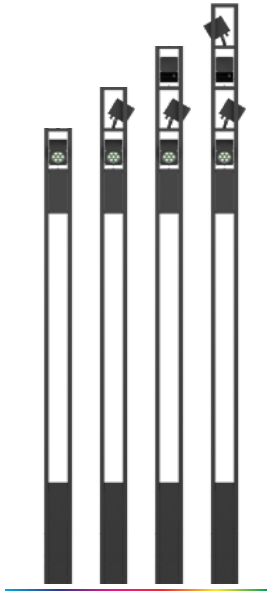

Vancouver 16

- UVA-20111-33w-1429lm [9.4"x9.4"-13.3"]
- UVA-20112-66w-4287lm [9.4"x9.4"-14.5"]
- UVA-20113-99w-5716lm [9.4"x9.4"-15.7"]
- UVA-20114-132w-7145lm [9.4"x9.4"-17"]

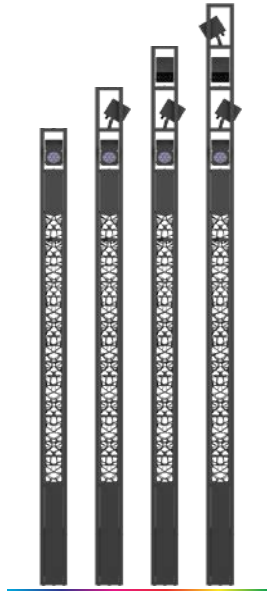

Vancouver 17

- UVA-20121-33w-2858 lm [9.4"x9.4"-13.3"]
- UVA-20122-66w-4287lm [9.4"x9.4"-14.5"]
- UVA-20123-99w-5716lm [9.4"x9.4"-15.7"]
- UVA-20124-132w-7145lm [9.4"x9.4"-17"]



Vancouver 18

- UVA-20131-33w-2858lm [9.4"x9.4"-13.3"]
- UVA-20132-66w-4287lm [9.4"x9.4"-14.5"]
- UVA-20133-99w-5716lm [9.4"x9.4"-15.7"]
- UVA-20134-132w-7145lm [9.4"x9.4"-17"]



Vancouver 19

- UVA-20141-33w-2858lm [9.4"x9.4"-13.3"]
- UVA-20142-66w-4287lm [9.4"x9.4"-14.5"]
- UVA-20143-99w-5716lm [9.4"x9.4"-15.7"]
- UVA-20144-132w-7145lm [9.4"x9.4"-17"]

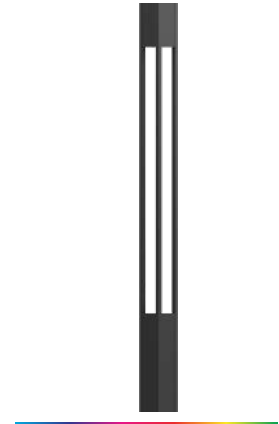

Vancouver 20

- UVA-20151-33w-1429lm [9.4"x9.4"-12.1"]



Vancouver 21

- UVA-20161-33w-1429lm [9.4"x9.4"-12.1"]



Vancouver 22

- UVA-20171-33w-1429lm [9.4"x9.4"-12.1"]

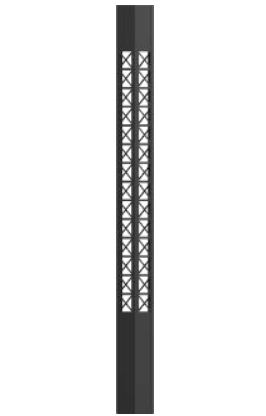

Vancouver 23

- UVA-20181-33w-1429lm [9.4"x9.4"-12.1"]



Vancouver 24

- UVA-30001-8w-331lm [6.3"x6.3"-15.7"]

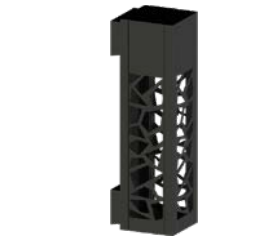

Vancouver 25

- UVA-30011-21w-570lm [6.3"x6.3"-23.6"]



Vancouver 26

- UVA-30012-21w-490lm [6.3"x6.3"-23.6"]



Vancouver 27

- UVA-30013-21w-740lm [6.3"x6.3"-23.6"]



Vancouver 28

- UVA-30021-39w-1336lm [9.4"x9.4"-39.3"]
- UVA-30031-33w RGBW-429lm [9.4"x9.4"-39.3"]



Vancouver 29

- UVA-30022-39w-1167lm [9.4"x9.4"-39.3"]
- UVA-30032-33w RGBW-1158lm [9.4"x9.4"-39.3"]



Vancouver 30

- UVA-30023-39w-1670lm [9.4"x9.4"-39.3"]
- UVA-30033-33w RGBW-439lm [9.4"x9.4"-39.3"]



Vancouver 31

• UVA-10101-7w-200lm [4.7" x 4.7" - 23.6"]



Vancouver 33

• UVA-10051-15w-1083lm [6.3" x 6.3" - 39.3"]



Vancouver 34

• UVA-10061-21w-1571lm [9.4" x 9.4" - 39.3"]



Vancouver 35

• UVA-10071-21w-1571lm [9.4" x 9.4" - 39.3"]



Vancouver 36

• UVA-10072-21w-1571lm [9.4" x 9.4" - 39.3"]



Vancouver 37

• UVA-10073-21w-1571lm [9.4" x 9.4" - 39.3"]



Vancouver 38

• UVA-10141-8w-95lm [4.7" x 4.7" - 23.6"]



Vancouver 39

• UVA-10151-15w-418lm [6.3" x 6.3" - 39.3"]



Vancouver 40

• UVA-10161-21w-635lm [9.4" x 9.4" - 39.3"]

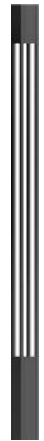

Vancouver 41

• UVA-20191-20w-1326lm [6.3" x 6.3" - 9.8"]

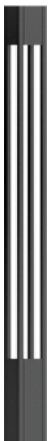

Vancouver 42

• UVA-20201-40w-2969 lm [9.4" x 9.4" - 14.7"]



Vancouver 43

• UVA-20211-39/21w-2781/1688lm [9.4"x9.4"-13.3"]



Vancouver 44

• UVA-20212-39/2x21w-2781/2x1688lm [9.4"x9.4"-14.5"]



Vancouver 45

• UVA-20213-39/3x21w-2781/3x1688lm [9.4"x9.4"-15.7"]



Vancouver 46

• UVA-20221-39/21w-4469/1688lm [9.4"x9.4"-13.3"]



Vancouver 47

• UVA-20221-39/2x21w-4469/2x1688lm [9.4"x9.4"-14.5']



Vancouver 48

• UVA-20223-39/3x21w-4469/3x1688lm [9.4"x9.4"-15.7']



Vancouver 49

• UVA-20231-39/21w-2781/1688lm [9.4"x9.4"-13.3']



Vancouver 50

• UVA-20232-39/2x21w-2781/2x1688lm [9.4"x9.4"-14.5']



Vancouver 51

• UVA-20233-39/2x21w-2781/2x1688lm [9.4"x9.4"-15.7']



Vancouver 52

• UVA-20241-40w-2781lm [9.4"x9.4"-12']



Vancouver 53

• UVA-20242-40w-2781lm [9.4"x9.4"-12']



Vancouver 54

• UVA-20243-40w-2781lm [9.4"x9.4"-12']



Vancouver 55

• UVA-20251-21w-710lm [6.3"x6.3"-9.8']



Vancouver 56

• UVA-20261-40w-1485lm [9.4"x9.4"-14.7']



Vancouver 60

• UVA-20281-94w-5120lm [9.4"x9.4"-12']



Vancouver 61

• UVA-20282-94w-5120lm [9.4"x9.4"-12']



Vancouver 62

• UVA-20283-94w-5120lm [9.4"x9.4"-12']



Vancouver 63

• UVA-70021-13w-437lm [6.3"x6.3"-15.7']



Vancouver 64

• UVA-70031-20w-1362lm [9.4"x9.4"-15.7']



Vancouver 65

• UVA-70041-8w-165lm [6.3"x6.3"-15.7"]



Vancouver 66

• UVA-70051-21w-410lm [9.4"x9.4"-15.7"]



Vancouver 67

• UVA-30041-20w-1326lm [6.3"x6.3"-23.6"]



Vancouver 68

• UVA-30042-20w-1326lm [6.3"x6.3"-23.6"]



Vancouver 69

• UVA-30043-20w-1326lm [6.3"x6.3"-23.6"]



Vancouver 70

• UVA-30051-40w-2781lm [9.4"x9.4"-39.3"]



Vancouver 71

• UVA-30052-40w-2781lm [9.4"x9.4"-39.3"]



Vancouver 72

• UVA-30053-40w-2781lm [9.4"x9.4"-39.3"]