

UTU-10166

Taurus 2 Bollard

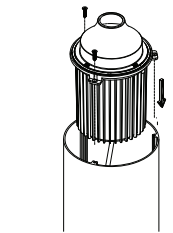

41w COB 765 Lumens
 IP55 • Suitable For Wet Locations
 IK08 • Impact Resistant (Vandal Resistant)
 Weight 18.5 lbs

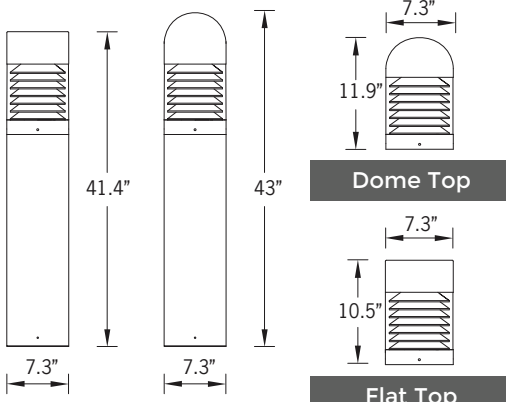

IP65 - Internal top access driver housing, prewired with SO cord and waterproof cable gland for easy installation.

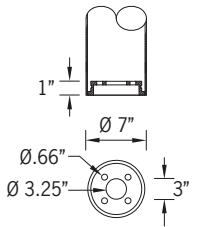

Construction

Aluminum

Less than 0.1% copper content - Marine Grade 6060 extruded & LM6 Aluminum High Pressure die casting provides excellent mechanical strength, clean detailed product lines and excellent heat dissipation.

Pre paint

8 step degrease and phosphate process that includes deoxidizing and etching as well as a zinc and nickel phosphate process before product painting.

Memory Retentive -Silicon Gasket

Provided with special injection molded "fit for purpose" long life high temperature memory retentive silicon gaskets. Maintains the gaskets exact profile and seal over years of use and compression.

Thermal management

LM6 Aluminum is used for its excellent mechanical strength and thermal dissipation properties in low and high ambient temperatures. The superior thermal heat sink design by Ligman used in conjunction with the driver, controls thermals below critical temperature range to ensure maximum luminous flux output, as well as providing long LED service life and ensuring less than 10% lumen depreciation at 50,000 hours.

Surge Suppression

Standard 10kv surge suppressor provided with all fixtures.

BUG Rating

B0 - U3 - G1

Finishing

All Ligman products go through an extensive finishing process that includes fettling to improve paint adherence.

Paint

UV Stabilized 4.9Mil thick powder coat paint and baked at 200 Deg C. This process ensures that Ligman products can withstand harsh environments. Rated for use in natatoriums.

Hardware

Provided Hardware is Marine grade 316 Stainless steel.

Anti Seize Screw Holes

Tapped holes are infused with a special anti seize compound designed to prevent seizure of threaded connections, due to electrolysis from heat, corrosive atmospheres and moisture.

Crystal Clear Low Iron Glass Lens

Provided with tempered, impact resistant crystal clear low iron glass ensuring no green glass tinge.

Optics & LED

Precise optic design provides exceptional light control and precise distribution of light. LED CRI > 80

Lumen - Maintenance Life

L80 /B10 at 50,000 hours (This means that at least 90% of the LED still achieve 80% of their original flux)

Plain, tranquil and secure bollard family. Pleasing, comfortable bollard choices with soft distributions and many options to fashion to project needs.

Taurus is an decorative bollard that is suitable for both modern and classic architecture. Ideal for creating visual guidance with exceptional visual comfort. This product was developed to complement the Taurus range of pillar lights, wall sconces and light columns. This sleek shape provides distinctive lighting effects by night and decorative urban effect during the day.

Suitable for pedestrian precincts, building surrounds, shopping centers, squares and parks. The luminaire is provided with a clear or opal ultra high impact UV stabilized acrylic lens that provides excellent low glare vertical and horizontal illumination.

The Taurus Bollard comes standard with a unique waterproof internal driver housing compartment that is situated at the top of the pole to stop water and dust from entering the electrical components. This fixture is supplied completely wired with powercord and waterproof gland from the driver enclosure to the base of the bollard ensuring quick trouble-free installation. Custom bollard heights are available, please specify. Color temperature 2700K, 3000K, 3500K and 4000K.

Custom wattages can be provided to suit customer and Title 24 requirements. (Specify total watts per fixture) This product has a matching Light Column as part of the family see UTU-20396.

Security Bollard:

This Bollard is available as a traffic rated security bollard. This optional design includes a 1/4" wall thickness galvanized steel security pole with 2 1" galvanized cross support rods that are embedded into concrete.

The standard security bollard provides restraint of vehicular traffic in unauthorized areas. Impact calculations shows this bollard will stop a 5,500lb/2.75 tons vehicle, travelling at 30mph. For additional strength, the galvanized pole must be filled with concrete up to the waterproof driver housing to provide a solid concrete barrier.

A K4 rated security bollard is also available. This bollard is provided with internal reinforcement and is to be filled with concrete at the job site by others. This bollard will stop a 15,000lb vehicle traveling at 30mph.

Additional Options (Consult Factory For Pricing)

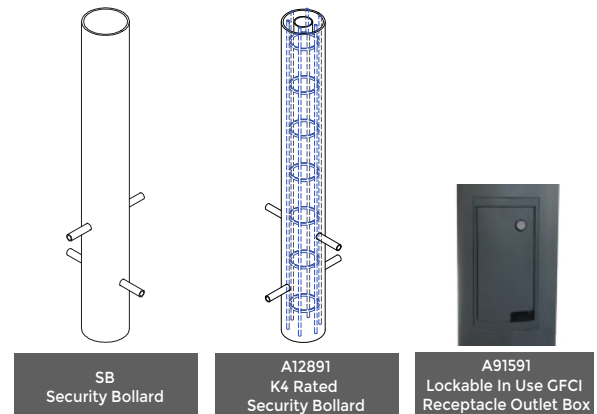



UTU-10166

Taurus 2 Bollard

PROJECT		DATE	
----------------	--	-------------	--

QUANTITY		TYPE		NOTE	
-----------------	--	-------------	--	-------------	--

ORDERING EXAMPLE || UTU - 10166 - 1 - 41w - W30 - 02 - 120/277v - Options

UTU-10166					
LAMP	TOP	LED COLOR	FINISH COLOR	VOLTAGE	
41w COB 765 Lumens	1 - Dome Top  2 - Flat Top 	W27 - 2700K W30 - 3000K W35 - 3500K W40 - 4000K	01 - BLACK RAL 9011 02 - DARK GREY RAL 7043 03 - WHITE RAL 9003 04 - METALLIC SILVER RAL 9006 05 - MATTE SILVER RAL 9006 06 - LIGMAN BRONZE 07 - CUSTOM RAL 	120/277v Other - Specify	

--	--	--	--

ADDITIONAL OPTIONS

- | | |
|------------------------------------|---|
| UL - Unlit Bollard | HGT - Custom Bollard Height [Specify HGT=XX"] |
| GFCI - GFCI Box | OCC1 - Single Occupancy Sensor |
| NAT - Natatorium Rated | OCC2 - Dual Occupancy Sensor |
| SB - Security Bollard | A91591 - Lockable In Use GFCI Receptacle Outlet Box |
| A12891 - K4 Rated Security Bollard | DIM - 0-10v Dimming |



A91591
Lockable In Use GFCI
Receptacle Outlet Box

Taurus Product Family



Taurus 1

- UTU-10136-41w-974lm [ø6.3"-29.4"/30.3"]
- UTU-10146-41w-974lm [ø6.3"-41.4"/42.3"]
- UTU-70107-41w-974lm [ø6.3"-18.8"/19.6"]



Taurus 2

- UTU-10156-41w-765lm [ø7.3"-29.4"/30.9"]
- UTU-10166-41w-765lm [ø7.3"-41.4"/42.9"]
- UTU-70117-41w-765lm [ø7.3"-18.8"/20.1"]



Taurus 3

- UTU-20396-41w-1096lm [ø6.3"]