

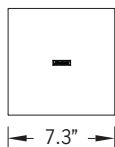

**6w LED 528 Lumens**  
**IP65 • Suitable For Wet Locations**  
**IK08 • Impact Resistant (Vandal Resistant)**  
**Weight 13.4 lbs**

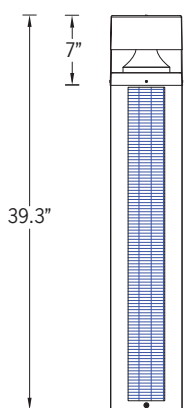

**Top View**

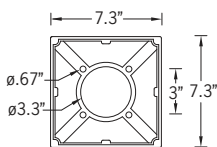

**Mounting Detail**

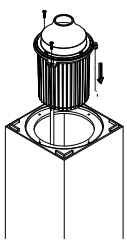

**IP65 - Internal top access driver housing, prewired with SO cord and waterproof cable gland for easy installation.**

**CITY OF FLAGSTAFF & TURTLE FRIENDLY COMPLIANT**

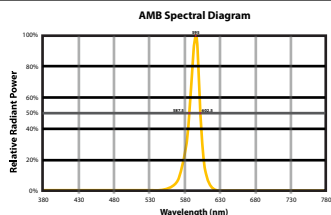

**Narrow-Spectrum Amber LEDs**

Peak wavelength between 585 & 595 nanometers and a full width of 50% power no greater than 15 nanometers.

**Construction**

**Aluminum**

Less than 0.1% copper content - Marine Grade 6060 extruded & LM6 Aluminum High Pressure die casting provides excellent mechanical strength, clean detailed product lines and excellent heat dissipation.

**Pre paint**

8 step de-grease and phosphate process that includes deoxidizing and etching as well as a zinc and nickel phosphate process before product painting.

**Memory Retentive - Silicon Gasket**

Provided with special injection molded "fit for purpose" long life high temperature memory retentive silicon gaskets. Maintains the gaskets exact profile and seal over years of use and compression.

**Thermal management**

LM6 Aluminum is used for its excellent mechanical strength and thermal dissipation properties in low and high ambient temperatures. The superior thermal heat sink design by Ligman used in conjunction with the driver, controls thermal below critical temperature range to ensure maximum luminous flux output, as well as providing long LED service life and ensuring less than 10% lumen depreciation at 50,000 hours.

**Surge Suppression**

Standard 10kv surge suppressor provided with all fixtures.

**BUG Rating**

Contact Factory

**Finishing**

All Ligman products go through an extensive finishing process that includes fettling to improve paint adherence.

**Paint**

UV Stabilized 4.9mil thick powder coat paint and baked at 200 Deg C. This process ensures that Ligman products can withstand harsh environments. Rated for use in natoriums.

**Inspired by Nature Finishes**

The Inspired by nature Finishing is a unique system of decorative powder coating. Our metal decoration process can easily transform the appearance of metal or aluminum product into a wood grain finish.

This patented technology enables the simulation of wood grain, and even marble or granite finish through the use of decorative powder coating.

The wood grain finish is so realistic that it's almost undistinguishable from real wood, even from a close visual inspection. The system of coating permeates the entire thickness of the coat and as a result, the coating cannot be removed by normal rubbing, chipping, or scratching.

**The Coating Process**

After pre-treatment the prepared parts are powder coated with a specially formulated polyurethane powder. This powder provides protection against wear, abrasion, impact and corrosion and acts as the relief base color for the finalized metal decoration.

The component is then wrapped with a sheet of non-porous film with the selected decoration pattern printed on it using special high temperature inks.

This printed film transfer is vacuum-sealed to the surface for a complete thermo print and then transferred into a customized oven. The oven transforms the ink into different forms within the paint layer before it becomes solid. Finally, the film is removed, and a vivid timber look on aluminum remains.

Wood grain coating can create beautiful wood-looking products of any sort. There are over 300 combinations of designs currently in use. Wood grains can be made with different colors, designs, etc.

Our powder coatings are certified for indoor and outdoor applications and are backed by a comprehensive warranty. These coatings rise to the highest conceivable standard of performance excellence and design innovation.

**Added Benefits**

- Resistance to salt-acid room, accelerated aging
- Boiling water, lime and condensed water resistant
- Anti-Graffiti, Anti-Slip, Anti-Microbial, Anti-Scratch
- Super durable (UV resistant)
- TGIC free (non-toxic)

**Hardware**

Provided Hardware is Marine grade 316 Stainless steel.

**Anti Seize Screw Holes**

Tapped holes are infused with a special anti seize compound designed to prevent seizure of threaded connections, due to electrolysis from heat, corrosive atmospheres and moisture.

**Crystal Clear Low Iron Glass Lens**

Provided with tempered, impact resistant crystal clear low iron glass ensuring no green glass tinge.

**Optics & LED**

Precise optic design provides exceptional light control and precise distribution of light.  
 LED CRI > 80

**Lumen - Maintenance Life**

L80 /B10 at 50,000 hours (This means that at least 90% of the LED still achieve 80% of their original flux)

**Indirect light-emitting bollard range. Smooth and sharp devised bollard family with wonderful soft controlled lighting options.**

**7.5 hours of operation time - 3.5 days of autonomy (100%)**

The innovative reflector technology of the Lightsoft bollard guarantees a high degree of efficiency and optimal visual comfort. Lightsoft has been developed to have excellent controlled downward light providing wide spacing ratios. It has three light shield accessories with different light distributions. The Lightsoft is available in a cylindrical or square shape design with two different heights. The Lightsoft Bollard comes standard with a unique waterproof internal driver housing compartment that is situated at the top of the pole to stop water and dust from entering the electrical components. This fixture is supplied completely wired with powercord and waterproof gland from the driver enclosure to the base of the bollard ensuring quick trouble-free installation. Custom bollard heights are available, please specify. Color temperature 2700K, 3000K, 3500K and 4000K. Custom wattages can be provided to suit customer and Title 24 requirements. (Specify total watts per fixture)

All Ligman fixtures can be manufactured using a special pre-treatment and coating process that ensures the fixture can be installed in natoriums as well as environments with high concentrations of chlorine or salt and still maintain the 5 year warranty. For this natorium rated process please specify NAT in options.

**Additional Options (Consult Factory For Pricing)**



**A10731**  
180° Light Shield



**A10831**  
90° Light Shield



**A92691**  
Remote Solar  
Charger Programmer

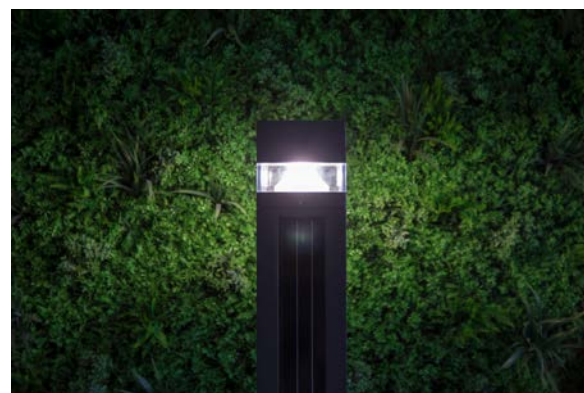
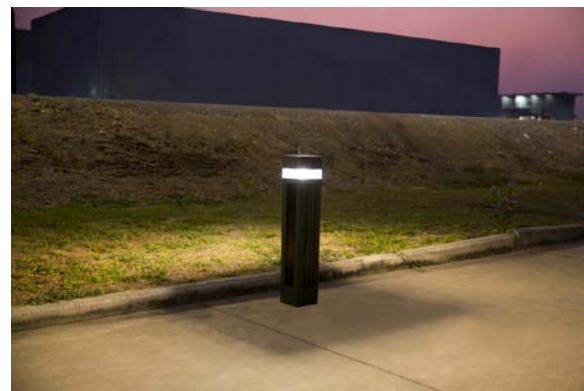

# ULH-10813

## Lightsoft 19 Solar Bollard

<b>PROJECT</b>	<input type="text"/>	<b>DATE</b>	<input type="text"/>
----------------	----------------------	-------------	----------------------

<b>QUANTITY</b>	<input type="text"/>	<b>TYPE</b>	<input type="text"/>	<b>NOTE</b>	<input type="text"/>
-----------------	----------------------	-------------	----------------------	-------------	----------------------

### ORDERING EXAMPLE || ULH - 10813 - 6w - T2 - W30 - 02 - Options

<b>ULH-10813</b>	<input type="text"/>	<input type="text"/>	<input type="text"/>	<input type="text"/>
<b>LAMP</b>	<b>BEAM</b>	<b>LED COLOR</b>	<b>FINISH COLOR</b>	
6w LED 528 Lumens	T2 - Type II Distribution T3 - Type III Distribution T4 - Type IV Distribution W - Wide Beam 108° EW - Extra Wide Beam 120°	W27 - 2700K W30 - 3000K W35 - 3500K W40 - 4000K	01 - BLACK RAL 9011 02 - DARK GREY RAL 7043 03 - WHITE RAL 9003 04 - METALLIC SILVER RAL 9006 05 - MATTE SILVER RAL 9006 06 - LIGMAN BRONZE 07 - CUSTOM RAL	

<input type="text"/>	<input type="text"/>	<input type="text"/>
<input type="text"/>	<input type="text"/>	<input type="text"/>

### ADDITIONAL OPTIONS

- |                            |   |
|----------------------------|---|
| A10731 - 180° Light Shield | HGT - Custom Bollard Height [Specify HGT=XX"] |
| A10831 - 90° Light Shield  | MS - Motion Sensor                            |
| NAT - Natatorium Rated     | A92691 - Remote Solar Charge Controller       |

- INSPIRED BY NATURE FINISHES**
- SW01 - OAK FINISH
  - SW02 - WALNUT FINISH
  - SW03 - PINE FINISH
  - DF - DOUGLAS FIR FINISH
  - CW - CHERRY WOOD FINISH
  - NW - NATIONAL WALNUT FINISH
  - SU01 - CONCRETE FINISH
  - SU02 - SOFTSCAPE FINISH
  - SU03 - STONE FINISH
  - SU04 - CORTEN FINISH
- THERE IS AN ADDITIONAL COST FOR THESE FINISHES

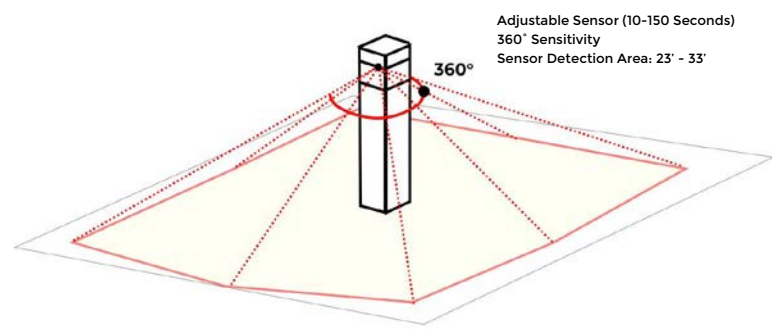

### More Custom Finishes Available Upon Request

Consult factory for pricing and lead times

Oak	Cherry	Beech	Carbon
Walnut	Chestnut	Bamboo	Galvanized
Pine	Mahogany	Birch	Steel



# Lightsoft Product Family



Lightsoft 1

- ULH-10655-27w-1188lm [23.6°]
- ULH-10665-27w-1188lm [39.3°]



Lightsoft 2

- ULH-10675-27w-1050lm [23.6°]
- ULH-10685-27w-1050lm [39.3°]



Lightsoft 3

- ULH-10573-14w-447lm [23.6°]
- ULH-10583-14w-447lm [39.3°]



Lightsoft 4

- ULH-10593-14w-346lm [23.6°]
- ULH-10603-14w-346lm [39.3°]



Lightsoft 5

- ULH-31146-14w-447lm



Lightsoft 6

- ULH-31156-14w-346lm



Lightsoft 19

- ULH-10811-2w-176lm
- ULH-10812-4w-352lm
- ULH-10813-6w-528lm