

# UJE-95091

## Jet 44 Square Pendant

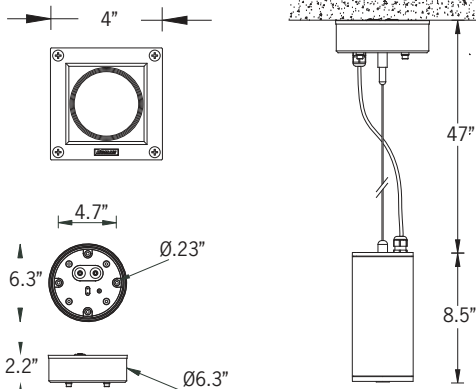

14w COB 1618 Lumens  
 IP65 • Suitable For Wet Locations  
 IK08 • Impact Resistant (Vandal Resistant)  
 Weight 5.3 lbs



Mounting Detail

### Construction

**Aluminum**  
 Less than 0.1% copper content – Marine Grade 6060 extruded & LM6 Aluminum High Pressure die casting provides excellent mechanical strength, clean detailed product lines and excellent heat dissipation.

**Pre paint**  
 8 step degrease and phosphate process that includes deoxidizing and etching as well as a zinc and nickel phosphate process before product painting.

**Memory Retentive -Silicon Gasket**  
 Provided with special injection molded "fit for purpose" long life high temperature memory retentive silicon gaskets. Maintains the gaskets exact profile and seal over years of use and compression.

**Thermal management**  
 LM6 Aluminum is used for its excellent mechanical strength and thermal dissipation properties in low and high ambient temperatures. The superior thermal heat sink design by Ligman used in conjunction with the driver, controls thermals below critical temperature range to ensure maximum luminous flux output, as well as providing long LED service life and ensuring less than 10% lumen depreciation at 50,000 hours.

**Surge Suppression**  
 Standard 10kv surge suppressor provided with all fixtures.

**BUG Rating**  
 B1 - U0 - G0

**Finishing**  
 All Ligman products go through an extensive finishing process that includes fettling to improve paint adherence.

**Paint**  
 UV Stabilized 4.9Mil thick powder coat paint and baked at 200 Deg C. This process ensures that Ligman products can withstand harsh environments. Rated for use in natatoriums.

**Inspired by Nature Finishes**  
 The Inspired by nature Finishing is a unique system of decorative powder coating. Our metal decoration process can easily transform the appearance of metal or aluminum product into a wood grain finish.

This patented technology enables the simulation of wood grain, and even marble or granite finish through the use of decorative powder coating.

The wood grain finish is so realistic that it's almost undistinguishable from real wood, even from a close visual inspection. The system of coating permeates the entire thickness of the coat and as a result, the coating cannot be removed by normal rubbing, chipping, or scratching.

**The Coating Process**  
 After pre-treatment the prepared parts are powder coated with a specially formulated polyurethane powder. This powder provides protection against wear, abrasion, impact and corrosion and acts as the relief base color for the finalized metal decoration.

The component is then wrapped with a sheet of non-porous film with the selected decoration pattern printed on it using special high temperature inks.

This printed film transfer is vacuum-sealed to the surface for a complete thermo print and then transferred into a customized oven. The oven transforms the ink into different forms within the paint layer before it becomes solid. Finally, the film is removed, and a vivid timber look on aluminum remains.

Wood grain coating can create beautiful wood-looking products of any sort. There are over 300 combinations of designs currently in use. Wood grains can be made with different colors, designs, etc.

Our powder coatings are certified for indoor and outdoor applications and are backed by a comprehensive warranty. These coatings rise to the highest conceivable standard of performance excellence and design innovation.

- Added Benefits**
- Resistance to salt-acid room, accelerated aging
  - Boiling water, lime and condensed water resistant
  - Anti-Graffiti, Anti-Slip, Anti-Microbial, Anti-Scratch
  - Super durable (UV resistant)
  - TGIC free (non-toxic)

**Hardware**  
 Provided Hardware is Marine grade 316 Stainless steel.

**Anti Seize Screw Holes**  
 Tapped holes are infused with a special anti seize compound designed to prevent seizure of threaded connections, due to electrolysis from heat, corrosive atmospheres and moisture.

**Crystal Clear Low Iron Glass Lens**  
 Provided with tempered, impact resistant crystal clear low iron glass ensuring no green glass tinge.

**Optics & LED**  
 Precise optic design provides exceptional light control and precise distribution of light.  
 LED CRI > 80

**Lumen - Maintenance Life**  
 L80 /B10 at 50,000 hours (This means that at least 90% of the LED still achieve 80% of their original flux)

**Cylindrical or rectangular form pendant downlight. High performance, high output and numerous options ensure jet can be configured for any application.**

A range of round or square shaped pendant exterior or interior downlight luminaires utilizing a combination of high output LEDs and precision optics that can provide Type II, III & IV distributions as well as Type V distributions with narrow, medium, wide and very wide beams.

The Type II, III & IV distribution options should be used to provide wide spacing to mounting height ratios with excellent uniformity.

This luminaire has specialized optics that have been designed by Ligman, in conjunction with internationally recognized optic designers to provide excellent light control, beam distribution and intensities by focusing each optic around the small LEDs to provide perfect focus and distribution. This luminaire can be provided with a variety of anti-glare and light control attachments.

This pendant range is available with 2 different suspension options.  
**Aircraft cable:** which can be field adjustable to suit design criteria and will always hang vertical, even if the fixture is bumped or moved.

**Rigid stem:** this option is supplied with a 1/2" rigid stem and swivel mount attachment that complies with seismic requirements, as well as sloped ceilings with angles up to 80°.

### Additional Options (Consult Factory For Pricing)

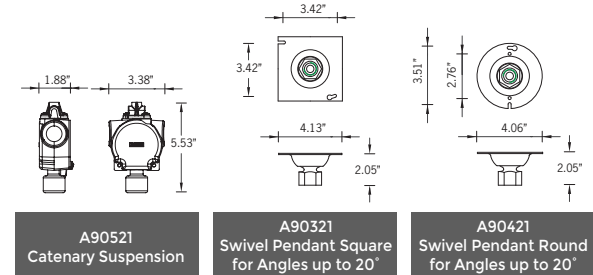

# UJE-95091

## Jet 44 Square Pendant

<b>PROJECT</b>		<b>DATE</b>	
----------------	--	-------------	--

<b>QUANTITY</b>		<b>TYPE</b>		<b>NOTE</b>	
-----------------	--	-------------	--	-------------	--

### ORDERING EXAMPLE || UJE - 95091 - 14w - M - W30 - 02 - 120/277v - Options

<b>UJE-95091</b>					
<b>LAMP</b>	<b>BEAM</b>	<b>LED COLOR</b>	<b>FINISH COLOR</b>	<b>VOLTAGE</b>	
14w COB 1618 Lumens	N - Narrow 20° M - Medium 24° W - Wide 36° VW - Very Wide 71°	W27 - 2700K W30 - 3000K W35 - 3500K W40 - 4000K	01 - BLACK RAL 9011 02 - DARK GREY RAL 7043 03 - WHITE RAL 9003 04 - METALLIC SILVER RAL 9006 05 - MATTE SILVER RAL 9006 06 - LIGMAN BRONZE 07 - CUSTOM RAL	120/277v Other - Specify	

--	--	--	--

### ADDITIONAL OPTIONS

- F - Frosted Lens
- DIM - 0-10v Dimming
- NAT - Natatorium Rated
- A90321 - Swivel Canopy Square
- AG - Anti Glare Baffle
- HEX - Hexcell Louvre
- A90421 - Swivel Canopy Round
- A90521 - Catenary Suspension
- SME - Swivel Mount Extension
- HGT - Custom Pendant Length
- LSL - Linear Spread Lens

**INSPIRED BY NATURE FINISHES**

- SW01 - OAK FINISH
- SW02 - WALNUT FINISH
- SW03 - PINE FINISH
- DF - DOUGLAS FIR FINISH
- CW - CHERRY WOOD FINISH
- NW - NATIONAL WALNUT FINISH
- SU01 - CONCRETE FINISH
- SU02 - SOFTSCAPE FINISH
- SU03 - STONE FINISH
- SU04 - CORTEN FINISH

THERE IS AN ADDITIONAL COST FOR THESE FINISHES

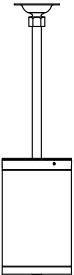

J-Box Swivel Mount Adapter  
Up to 20°

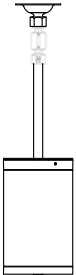

J-Box Swivel Mount Adapter  
Up to 80° with SME option

### More Custom Finishes Available Upon Request

Consult factory for pricing and lead times

Oak	Cherry	Beech	Carbon
Walnut	Chestnut	Bamboo	Galvanized
Pine	Mahogany	Birch	Steel



# Jet Product Family



Jet 31

• UJE-30351-15w-1618lm [ø4"] - Down



Jet 32

• UJE-30371-15w-1618lm [4"x4"] - Down



Jet 33

• UJE-30391-39w-4094lm [ø6.3"] - Down



Jet 34

• UJE-30411-39w-4094lm [6.3"x6.3"] - Down



Jet 35

• UJE-30341-2x15w-2x1618lm [ø4"] - Up/Down



Jet 36

• UJE-30361-2x15w-2x1618lm [4"x4"] - Up/Down



Jet 37

• UJE-30381-2x39w-2x4094lm [ø6.3"] - Up/Down



Jet 38

• UJE-30401-2x39w-2x4094lm [6.3"x6.3"] - Up/Down



Jet 39

• UJE-80031-14w-1618lm [ø4"]



Jet 40

• UJE-80041-15w-1618lm [4"x4"]



Jet 41

• UJE-80051-39w-4094lm [ø6.3"-11.6"]  
• UJE-80052-20w-2284lm [ø6.3"-5.5"]



Jet 42

• UJE-80061-39w-4094lm [6.3"x6.3"-11.6"]  
• UJE-80062-20w-2284lm [6.3"x6.3"-5.5"]



Jet 43

• UJE-95081-14w-1618lm [ø4"]



Jet 44

• UJE-95091-14w-1618lm [4"x4"]



Jet 45

• UJE-95111-39w-4094lm [ø6.3"]



Jet 46

• UJE-95121-39w-4094lm [6.3"x6.3"]



Jet 47

• UJE-10555-15w-1618lm

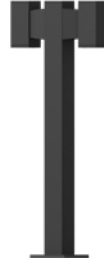

Jet 48

• UJE-10565-2x15w-2x1618lm

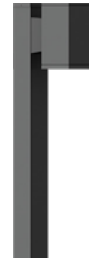

Jet 49

• UJE-20001-35w-4094lm

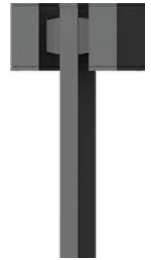

Jet 50

• UJE-20002-2x35w-2x4094lm



Jet 51

• UJE-10581-2x10w-2x1132lm  
• UJE-10582-2x18w-2x2135lm  
• UJE-10583-2x15w-2x1191lm



Jet 52

• UJE-30413-33w RGBW-1429lm [6.3"x6.3"] - Down



Jet 53

• UJE-30383-2x33w RGBW-2x1429lm [ø6.3"] - Up/Down



Jet 54

• UJE-30403-2x33w RGBW-2x1429lm [6.3"x6.3"] - Up/Down



Jet 57

• UJE-10571-10w-1132lm  
• UJE-10572-18w-2135lm  
• UJE-10573-15w-1191lm



Jet 58

• UJE-10581-2x10w-2x1132lm  
• UJE-10582-2x18w-2x2135lm  
• UJE-10583-2x15w-2x1191lm