

# UKWH-30001

## KWH 1 Surface Sconce & Floodlight

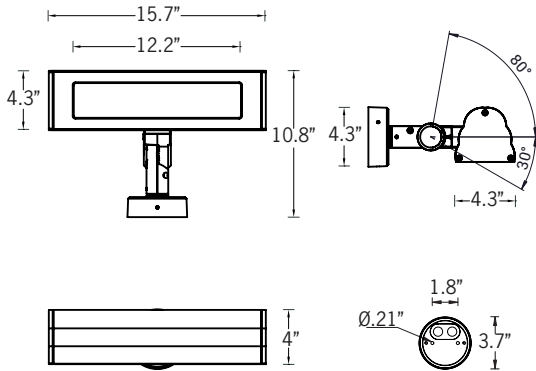

20w LED 2591 Lumens  
IP65 • Suitable For Wet Locations  
IK07 • Impact Resistant  
Weight 8.7 lbs



Mounting Detail

### Construction

#### Aluminum

Less than 0.1% copper content - Marine Grade 6060 extruded & LM6 Aluminum High Pressure die casting provides excellent mechanical strength, clean detailed product lines and excellent heat dissipation.

#### Pre-paint

8 step degrease and phosphate process that includes deoxidizing and etching as well as a zinc and nickel phosphate process before product painting.

#### Memory Retentive -Silicon Gasket

Provided with special injection molded "fit for purpose" long life high temperature memory retentive silicon gaskets. Maintains the gaskets exact profile and seal over years of use and compression.

#### Thermal management

LM6 Aluminum is used for its excellent mechanical strength and thermal dissipation properties in low and high ambient temperatures. The superior thermal heat sink design by Ligman used in conjunction with the driver, controls thermals below critical temperature range to ensure maximum luminous flux output, as well as providing long LED service life and ensuring less than 10% lumen depreciation at 50,000 hours.

#### Surge Suppression

Standard 10kv surge suppressor provided with all fixtures.

#### BUG Rating

Contact Factory

#### Finishing

All Ligman products go through an extensive finishing process that includes fettling to improve paint adherence.

#### Paint

UV Stabilized 4.9Mil thick powder coat paint and baked at 200 Deg C. This process ensures that Ligman products can withstand harsh environments. Rated for use in natatoriums.

#### Inspired by Nature Finishes

The Inspired by nature Finishing is a unique system of decorative powder coating. Our metal decoration process can easily transform the appearance of metal or aluminum product into a wood grain finish.

This patented technology enables the simulation of wood grain, and even marble or granite finish through the use of decorative powder coating.

The wood grain finish is so realistic that it's almost undistinguishable from real wood, even from a close visual inspection. The system of coating permeates the entire thickness of the coat and as a result, the coating cannot be removed by normal rubbing, chipping, or scratching.

#### The Coating Process

After pre-treatment the prepared parts are powder coated with a specially formulated polyurethane powder. This powder provides protection against wear, abrasion, impact and corrosion and acts as the relief base color for the finalized metal decoration.

The component is then wrapped with a sheet of non-porous film with the selected decoration pattern printed on it using special high temperature inks.

This printed film transfer is vacuum-sealed to the surface for a complete thermo print and then transferred into a customized oven. The oven transforms the ink into different forms within the paint layer before it becomes solid. Finally, the film is removed, and a vivid timber look on aluminum remains.

Wood grain coating can create beautiful wood-looking products of any sort. There are over 300 combinations of designs currently in use. Wood grains can be made with different colors, designs, etc.

Our powder coatings are certified for indoor and outdoor applications and are backed by a comprehensive warranty. These coatings rise to the highest conceivable standard of performance excellence and design innovation.

#### Added Benefits

- Resistance to salt-acid room, accelerated aging
- Boiling water, lime and condensed water resistant
- Anti-Graffiti, Anti-Slip, Anti-Microbial, Anti-Scratch
- Super durable (UV resistant)
- TGIC free (non-toxic)

#### Hardware

Provided Hardware is Marine grade 316 Stainless steel.

#### Anti Seize Screw Holes

Tapped holes are infused with a special anti seize compound designed to prevent seizure of threaded connections, due to electrolysis from heat, corrosive atmospheres and moisture.

#### Crystal Clear Low Iron Glass Lens

Provided with tempered, impact resistant crystal clear low iron glass ensuring no green glass tinge.

#### Optics & LED

Precise optic design provides exceptional light control and precise distribution of light.  
LED CRI > 80

#### Lumen - Maintenance Life

L80 /B10 at 50,000 hours (This means that at least 90% of the LED still achieve 80% of their original flux)

Clean, slim, surface wall fixtures with class leading performance.

The KWH luminaire provides a small profile luminaire with clean crisp lines and lateral expandability, maintaining a minimalistic uniform visual sideways appearance while offering a variety of lumen packages.

These luminaires have rotatable and interchangeable microVOS optics and are also available with integral emergency battery backup solutions.

Powerful, flexible and cost-effective family with vast array of technical optic choices.

A range of small profile, linear surface wall or ground mounted luminaires with options of upward or downward light distributions. Ideally suited to illuminate the wall and surfaces in front of wall and for light accents on vertical surfaces using high efficiency LED's. The KWH is suitable for indoor and outdoor applications and provides a clean, visually appealing solution for a small, unobtrusive surface mounted luminaire.

This luminaire is available in 3 different sizes utilizing microVos technology, meaning the ability to do Type I,II,III,IV & V distributions as well as hybrid distributions to suit the designer's requirements.

Using the microVos optics allows for very wide spacing to mounting height ratios, while still providing perfect uniformity and code compliant light levels.

### Additional Options (Consult Factory For Pricing)



TKM Threaded Knuckle Mount

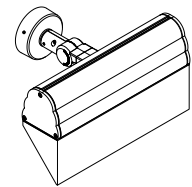

VIS Visor

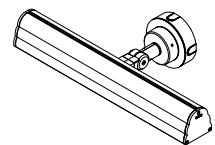
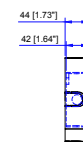
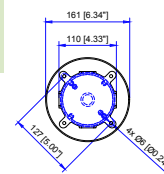

SCBT Surface Conduit Box Trim

NOTE: This trim covers a shallow single gang, surface mount junction box [Provided by contractor] Example: Hubbell - 5361-0 - 1-Gang Weatherproof Box, Five 1/2" in. Threaded Outlets - or 5372-0 - 1-Gang Weatherproof Box, Five 3/4 in. Threaded Outlets

Ligman's micro Variable Optical System provides the ability to interchange, mix & rotate optics to provide specific light distributions for optimized spacing and uniformity.

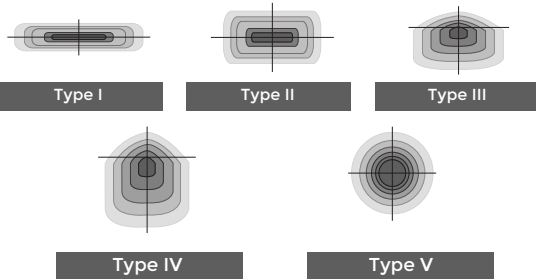

The variable optic system allows for the designer to create hybrid distributions for precise lighting requirements.

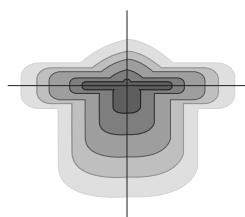

HYBRID TYPE I & TYPE IV

# UKWH-30001

KWH 1 Surface Sconce & Floodlight



<b>PROJECT</b>		<b>DATE</b>	
----------------	--	-------------	--

<b>QUANTITY</b>		<b>TYPE</b>		<b>NOTE</b>	
-----------------	--	-------------	--	-------------	--

ORDERING EXAMPLE || UKWH - 30001 - 20w - T2 - W30 - 02 - 120/277v - Options

<b>UKWH-30001</b>					
	<b>LAMP</b>	<b>BEAM</b>	<b>LED COLOR</b>	<b>FINISH COLOR</b>	<b>VOLTAGE</b>
	20w LED 2591 Lumens	T1 - Type I Distribution T2 - Type II Distribution T3 - Type III Distribution T4 - Type IV Distribution M - Medium 31° W - Wide 55° EW - Extra Wide 107° ME - Type ME Distribution SCL - Type SCL Distribution	W27 - 2700K W30 - 3000K W35 - 3500K W40 - 4000K	01 - BLACK RAL 9011 02 - DARK GREY RAL 7043 03 - WHITE RAL 9003 04 - METALLIC SILVER RAL 9006 05 - MATTE SILVER RAL 9006 06 - LIGMAN BRONZE 07 - CUSTOM RAL	120/277v Other - Specify

--	--	--

## ADDITIONAL OPTIONS

- |                                |                                  |
|--------------------------------|----------------------------------|
| DIM - 0-10v Dimming            | IHSS- Internal House Side Shield |
| NAT - Natatorium Rated         | TKM - Threaded Knuckle Mount     |
| F - Frosted Lens               | VIS - Visor                      |
| EMG - Emergency Battery Backup | SCBT - Surface Conduit Box Trim  |

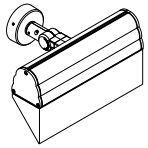

VIS  
Visor

INSPIRED BY NATURE FINISHES	
SW01 - OAK FINISH	
SW02 - WALNUT FINISH	
SW03- PINE FINISH	
DF - DOUGLAS FIR FINISH	
CW - CHERRY WOOD FINISH	
NW - NATIONAL WALNUT FINISH	
SU01 - CONCRETE FINISH	
SU02 - SOFTSCAPE FINISH	
SU03 - STONE FINISH	
SU04 - CORTEN FINISH	

THERE IS AN ADDITIONAL COST FOR THESE FINISHES

## More Custom Finishes Available Upon Request

Consult factory for pricing and lead times

Oak	Walnut	Pine	Cherry	Chestnut	Mahogany	Beech	Bamboo	Birch	Carbon	Galvanized	Steel



Ligman Lighting USA reserves the right to change specifications without prior notice, please contact factory for latest information. Due to the continual improvements in LED technology data and components may change without notice.



# KWH Product Family



KWH 1

- UKWH-30001-19w-2591lm
- UKWH-30001-48w RGBW-2513lm



KWH 2

- UKWH-30011-31w-5182lm
- UKWH-30011-73w RGBW-4136lm



KWH 3

- UKWH-30021-60w-7778lm
- UKWH-30021-90w RGBW-5593lm



KWH 4

- UKWH-20001-20w-2591lm



KWH 5

- UKWH-20011-38w-5182lm



KWH 6

- UKWH-20021-60w-7200lm



KWH 7

- UKWH-50001-54w-5643lm
- UKWH-50002-48w RGBW-2719lm
- UKWH-50003-45w RGBWTW-2946lm



KWH 8

- UKWH-50011-105w-11391lm
- UKWH-50012-92w RGBW-5438lm
- UKWH-50013-92w RGBWTW-5892lm



KWH 9

- UKWH-50021-78w-8543lm
- UKWH-50022-70w RGBW-4078lm
- UKWH-50023-70w RGBWTW-4419lm



KWH 10

- UKWH-50031-152w-17087lm
- UKWH-50032-136w RGBW-8157lm
- UKWH-50033-136w RGBWTW-8837lm



KWH 11

- UKWH-50041-103w-11391lm
- UKWH-50042-93w RGBW-5438lm
- UKWH-50043-93w RGBWTW-5892lm



KWH 12

- UKWH-50051-202w-22783lm
- UKWH-50052-182w RGBW-10876lm
- UKWH-50053-182w RGBWTW-11783lm