

USE-90032

Steamer Large Round Streetlight



209w LED
27111 Lumens

157w LED
15997 Lumens

120w LED
12227 Lumens

80w LED
8151 Lumens

29w LED
2954 Lumens

Weight 35.5 lbs

IP66
Suitable for wet locations

IK08
Impact Resistant [Vandal Resistant]

EPA - 1.91

POLE NOT INCLUDED

Construction

Aluminum
Less than 0.1% copper content - Marine Grade 6060 extruded & LM6 Aluminum High Pressure die casting provides excellent mechanical strength, clean detailed product lines and excellent heat dissipation.

Pre paint
8 step degrease and phosphate process that includes deoxidizing and etching as well as a zinc and nickel phosphate process before product painting.

Memory Retentive - Silicon Gasket
Provided with special injection molded "fit for purpose" long life high temperature memory retentive silicon gaskets. Maintains the gaskets exact profile and seal over years of use and compression.

Thermal management
LM6 Aluminum is used for its excellent mechanical strength and thermal dissipation properties in low and high ambient temperatures. The superior thermal heat sink design by Ligman used in conjunction with the driver, controls thermals below critical temperature range to ensure maximum luminous flux output, as well as providing long LED service life and ensuring less than 10% lumen depreciation at 50,000 hours.

BUG Rating
B2 - U0 - G2

Surge Suppression
Standard 10kv surge suppressor provided with all fixtures.

Finishing.
All Ligman products go through an extensive finishing process that includes fettling to improve paint adherence.

Paint
UV Stabilized 4.9Mil thick powder coat paint and baked at 200 Deg C. This process ensures that Ligman products can withstand harsh environments. Rated for use in natatoriums.

Inspired by Nature Finishes
The Inspired by nature Finishing is a unique system of decorative powder coating. Our metal decoration process can easily transform the appearance of metal or aluminum product into a wood grain finish.

This patented technology enables the simulation of wood grain, and even marble or granite finish through the use of decorative powder coating.

The wood grain finish is so realistic that it's almost undistinguishable from real wood, even from a close visual inspection. The system of coating permeates the entire thickness of the coat and as a result, the coating cannot be removed by normal rubbing, chipping, or scratching.

The Coating Process
After pre-treatment the prepared parts are powder coated with a specially formulated polyurethane powder. This powder provides protection against wear, abrasion, impact and corrosion and acts as the relief base color for the finalized metal decoration.

The component is then wrapped with a sheet of non-porous film with the selected decoration pattern printed on it using special high temperature inks.

This printed film transfer is vacuum-sealed to the surface for a complete thermo print and then transferred into a customized oven. The oven transforms the ink into different forms within the paint layer before it becomes solid. Finally, the film is removed, and a vivid timber look on aluminum remains.

Wood grain coating can create beautiful wood-looking products of any sort. There are over 300 combinations of designs currently in use. Wood grains can be made with different colors, designs, etc.

Our powder coatings are certified for indoor and outdoor applications and are backed by a comprehensive warranty. These coatings rise to the highest conceivable standard of performance excellence and design innovation.

Added Benefits

- Resistance to salt-acid room, accelerated aging
- Boiling water, lime and condensed water resistant
- Anti-Graffiti, Anti-Slip, Anti-Microbial, Anti-Scratch
- Super durable (UV resistant)
- TGIC free (non-toxic)

Hardware
Provided Hardware is Marine grade 316 Stainless steel.

Anti Seize Screw Holes
Tapped holes are infused with a special anti seize compound designed to prevent seizure of threaded connections, due to electrolysis from heat, corrosive atmospheres and moisture.

Crystal Clear Low Iron Glass Lens
Provided with tempered, impact resistant crystal clear low iron glass ensuring no green glass tinge.

Optics & LED
Precise optic design provides exceptional light control and precise distribution of light.
LED CRI > 80

Lumen - Maintenance Life
L80 /B10 at 50,000 hours (This means that at least 90% of the LED still achieve 80% of their original flux)

Column-mounted contemporary area lighting family. Modern and powerful high-end column range using optimum-quality area lighting projectors.

A slim wedge shaped, high pressure die-cast pole mounted area light with a variety of different light distributions to suit all lighting designer's requirements.

This luminaire has been designed to provide excellent light distribution patterns using highly efficient LED packages and optics. The result is excellent spacing to mounting height ratios, with a uniform lighting layout that meets code requirements using less energy.

The Steamer can be utilized to suit specific light patterns using the asymmetrical type II, III, IV and ME optics, as well as variations of these for precise light distribution requirements. An example of this is using a combination of Type II & Type IV distribution optics inside the same fixture. Type V distributions in medium, wide, very wide & extra wide are also available, please contact factory.

This luminaire complies to dark sky requirements when mounted in the horizontal position. Designed for lighting private roadways, car parks, exhibition areas, service stations and truck stops. Internal house side shields are available as an option.





Available with a selection of integral electronic and dimmable electronic drivers as well as a provision to install occupancy sensors, as well as wireless lighting controls to integrate with building management systems. (WATT-ADJUST) This luminaire is provided with a programmable driver so that specific wattage requirements can be achieved. These settings are done at the factory during assembly. (See options below)

NOTE: Standard luminaires are manufactured to be mounted for downward lighting only.

Uplight options can be provided. Please contact factory for more information.

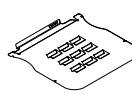
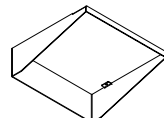
To meet International Dark Sky criteria, 3000k or warmer LEDs must be selected and luminaire fix mounted (+/- 15° allowable to permit leveling).

Additional Options (Consult Factory For Pricing)

 For T1,T2,T3,T5 & ME	 For T4	
IHSS Integrated House Side Shield	IHSS Integrated House Side Shield	EHSS External House Side Shield
		
A90991 Zhaga Book 18	A90891 NEMA 7	BD Bird Deterrent Spikes



LIGHCONNECT IoT Ready Steamer

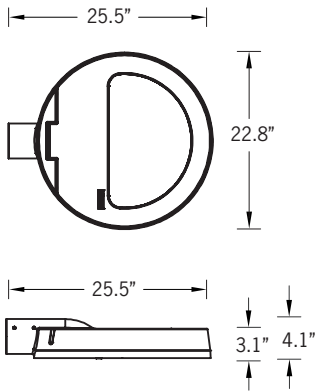

Ligman's micro Variable Optical System provides the ability to interchange, mix & rotate optics to provide specific light distributions for optimized spacing and uniformity.

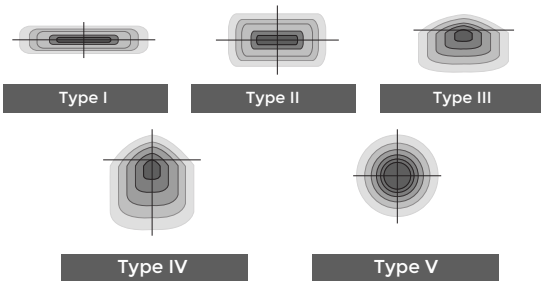

The variable optic system allows for the designer to create hybrid distributions for precise lighting requirements.

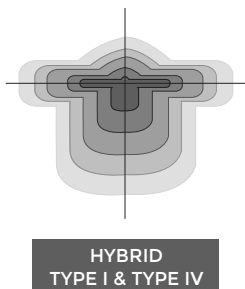

USE-90032

Steamer Large Round Streetlight



ACCESSORIES - SINGLE HEAD

Tenon Mount
Without decorative
back post
L Shape, Large Head
A91060-L-L - 2.36" Tenon
A91076-L-L - 2.99" Tenon



With decorative back post
T Shape, Large Head
A91060-T-L - 2.36" Tenon
A91076-T-L - 2.99" Tenon



Tenon Mount
Without decorative
back post
L Shape, Large Head
A91260-L-L - 2.36" Tenon
A91276-L-L - 2.99" Tenon



With decorative back post
T Shape, Large Head
A91260-T-L - 2.36" Tenon
A91276-T-L - 2.99" Tenon



Tenon Mount
Without decorative
back post
L Shape, Large Head
A91660-L-L - 2.36" Tenon
A91676-L-L - 2.99" Tenon



With decorative back post
T Shape, Large Head
A91660-T-L - 2.36" Tenon
A91676-T-L - 2.99" Tenon

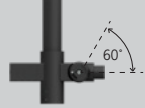

A91460 - 2.36" Tenon
A91476 - 2.99" Tenon
EPA: 1.85ft²

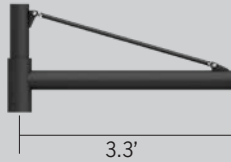

EA
EPA: 2.38 ft²



GA
EPA: 2.38ft²

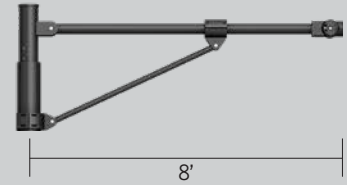

ACCESSORIES - DOUBLE HEAD



A91160 - 2.36" Tenon
A91176 - 2.99" Tenon
EPA: 0.71ft²



A91360 - 2.36" Tenon
A91376 - 2.99" Tenon
EPA: 0.95ft²

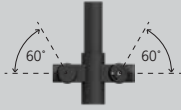

A91760 - 2.36" Tenon
A91776 - 2.99" Tenon
EPA: 0.97ft²

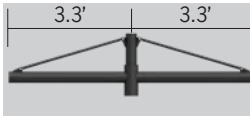

A91560 - 2.36" Tenon
A91576 - 2.99" Tenon
EPA: 2.88ft²

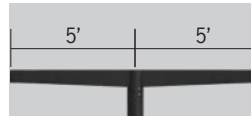

EA2
EPA: 4.76 ft²



GA2
EPA: 4.26ft²

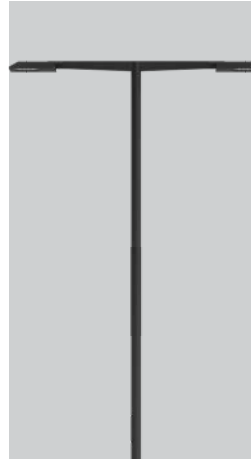

ACCESSORIES - TRIPLE HEAD



A92260 - 2.36" Tenon
A92276 - 2.99" Tenon



A92360 - 2.36" Tenon
A92376 - 2.99" Tenon



USE-90032

Steamer Large Round Streetlight



PROJECT		DATE	
----------------	--	-------------	--

QUANTITY		TYPE		NOTE	
-----------------	--	-------------	--	-------------	--

ORDERING EXAMPLE || USE-90032 - 209w - T2 - W30 - 02 - 120/277v

USE-90032					
LAMP	BEAM	LED COLOR	FINISH COLOR	VOLTAGE	
209w LED - 2711lm 157w LED - 15997lm 120w LED - 12227lm 80w LED - 8151lm 29w LED - 2954lm WATT-ADJUST (Factory programmed to specific wattage)	T1 - Type I Distribution T2 - Type II Distribution T3 - Type III Distribution T4 - Type IV Distribution ME - Type ME Distribution M - Medium 30" W - Wide 57" EW - Extra Wide 105"x115"	W27 - 2700K W30 - 3000K W35 - 3500K W40 - 4000K	01 - BLACK RAL 9011 02 - DARK GREY RAL 7043 03 - WHITE RAL 9003 04 - METALLIC SILVER RAL 9006 05 - MATTE SILVER RAL 9006 06 - LIGMAN BRONZE 07 - CUSTOM RAL	120/277v Other - Specify	
INSPIRED BY NATURE FINISHES					
SW01 - OAK FINISH SW02 - WALNUT FINISH SW03 - PINE FINISH DF - DOUGLAS FIR FINISH CW - CHERRY WOOD FINISH NW - NATIONAL WALNUT FINISH SU01 - CONCRETE FINISH SU02 - SOFTSCAPE FINISH SU03 - STONE FINISH SU04 - CORTEN FINISH					
THERE IS AN ADDITIONAL COST FOR THESE FINISHES					

POLE TOP ACCESSORIES [See Page 2]

ADDITIONAL OPTIONS - CONSULT FACTORY FOR PRICING
DIM - 0-10v Dimming BD - Bird Deterrent Spikes F - Frosted Lens IHSS - Internal House Side Shield EHSS - External House Side Shield AMB - Turtle Friendly Amber LED
A90991-U - Zhaga Book 18 Mounted On Top of Fixture A90991-D - Zhaga Book 18 Mounted Below Fixture A90891 - NEMA 7 OS - FSP Occupancy Sensor [See last page] FSIR - Occupancy Sensor Remote Programmer [See last page]

More Custom Finishes Available Upon Request

Consult factory for pricing and lead times

<table style="width: 100%;"> <tr> <td></td> <td></td> </tr> <tr> <td>Oak</td> <td>Walnut</td> </tr> <tr> <td></td> <td></td> </tr> <tr> <td>Pine</td> <td>Mahogany</td> </tr> <tr> <td></td> <td></td> </tr> <tr> <td>Beech</td> <td>Carbon</td> </tr> <tr> <td></td> <td></td> </tr> <tr> <td>Bamboo</td> <td>Galvanized</td> </tr> <tr> <td></td> <td></td> </tr> <tr> <td>Birch</td> <td>Steel</td> </tr> </table>			Oak	Walnut			Pine	Mahogany			Beech	Carbon			Bamboo	Galvanized			Birch	Steel	<table style="width: 100%;"> <tr> <td></td> <td></td> </tr> <tr> <td>Cherry</td> <td>Chestnut</td> </tr> </table>			Cherry	Chestnut
Oak	Walnut																								
Pine	Mahogany																								
Beech	Carbon																								
Bamboo	Galvanized																								
Birch	Steel																								
Cherry	Chestnut																								



Example: Inspired by Nature Finish

HIGH/LOW/OFF PIR OUTDOOR PHOTO/MOTION SENSOR IP66 - Integrated photocell

Ligman provides integrated photocell control using the wattstopper legrand FSP-221B. These units are installed inside the fixture housing with only the external lenses being visible



FSP-221B

Dimensions of Lens Options

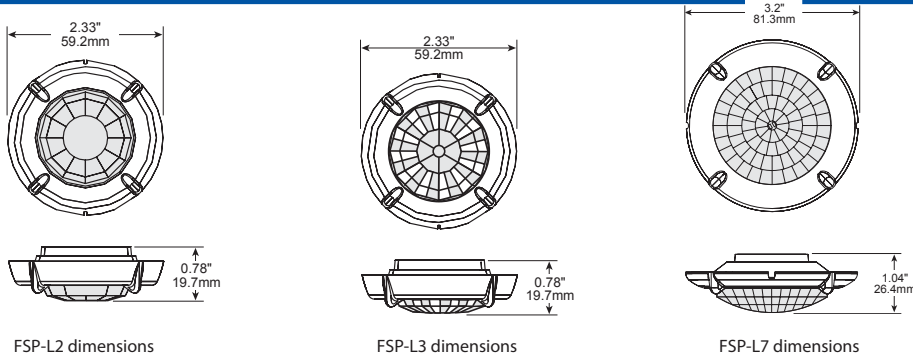

Product Overview

The FSP-221B is a family of passive infrared (PIR) outdoor sensors that raise or lower the electric lighting level to high, low or off based on motion and/or daylight contribution. Typically, once the sensor stops detecting movement and the time delay elapses, lights will first fade to low mode, and eventually switch off. When motion is detected, the sensor ramps the light level to high mode unless the daylight contribution is sufficient.

The integral photocell can also switch the lights on and off for dusk to dawn control, so that lighting remains on overnight even without motion detection.

The sensors control 0-10VDC or nondimming LED drivers or ballasts.

The low voltage FSP-201B may be used with dim-to-off drivers or ballasts.

Initial setup and subsequent sensor adjustments are made using a Wireless Handheld Configuration Tool (FSIR-100). This tool enables adjustment of sensor parameters including high/low mode, sensitivity, time delay, cut off and more.

The FSIR-100 can read current parameter settings, and stores up to six sensor parameter profiles to speed commissioning of multiple sensors.

Coverage

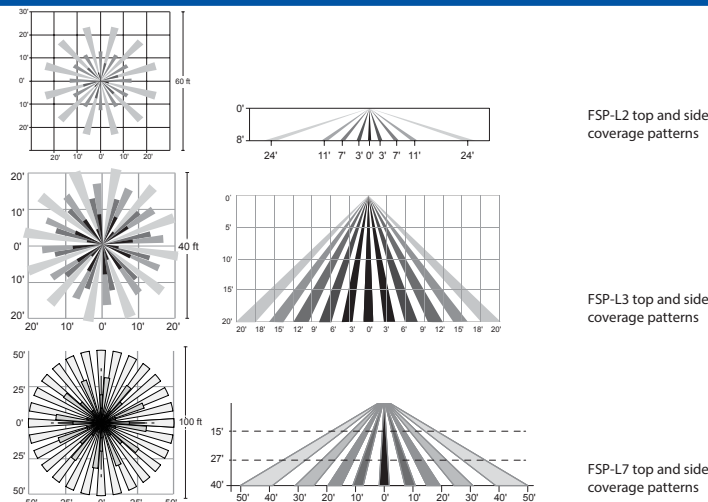

Models

FSP-221B, 100-347 VAC

Specifications and Features



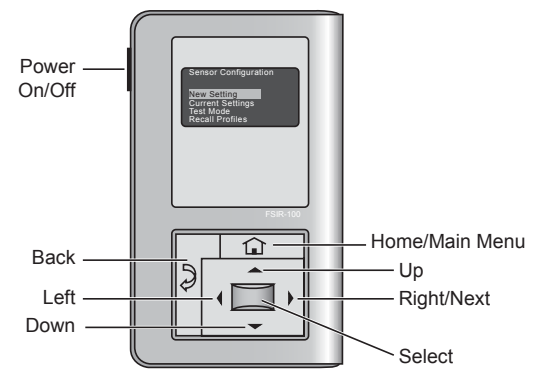

- Three interchangeable lenses for mounting between 8' and 40'
- Remote setup and adjustment with handheld wireless configuration tool
- Adjustable high and low modes (high: 0 to 10V, low: off, 0 to 9.8V)
- Adjustable time delay (30 seconds, 1 to 30 minutes)
- Adjustable cut off delay (none, 1 to 59 minutes, 1 to 5 hours)
- Adjustable sensitivity/service mode (low, med, max; on-fix, off-fix)
- Adjustable setpoints: hold off setpoint (none, 1 to 250 fc, auto); photocell on/off setpoint (1 to 250 fc)
- Adjustable ramp and fade times (1 to 60 seconds)
- Operating temperature: -40°F to +167°F (-40°C to +75°C)
- IP66 rated
- Five year warranty

Factory Defaults

High mode:	10V
Low mode:	1V
Time delay:	5 minutes
Cut off:	1 hour
Setpoint:	Disabled
Sensitivity:	Max
Ramp up time:	Disabled
Fade down time:	Disabled
Photocell On/Off:	Disabled



The FSIR-100 is a convenient handheld remote tool for sensor setting. Adjustable settings can be changed as needed for specific applications.

Catalog #	Color	Description
 FSP-L2	White/Grey/Black/Brown <small>The Trim color option will be selected to closest match fixture color. e.g (Matte silver fixture - grey trim)</small>	360° lens, maximum coverage 48' diameter from 8' height
 FSP-L3	White/Grey/Black/Brown <small>The Trim color option will be selected to closest match fixture color. e.g (Matte silver fixture - grey trim)</small>	360° lens, maximum coverage 40' diameter from 20' height
 FSP-L7	White/Grey/Black/Brown <small>The Trim color option will be selected to closest match fixture color. e.g (Matte silver fixture - grey trim)</small>	360° lens, maximum coverage 100' diameter from 40' height
 FSIR-100	Black	Remote Handheld Configuration Tool