

# UMC-20002

## Macaron 1 Post Top



**104w LED**  
14374 Lumens

**IP66**  
Suitable for wet locations

**IK08**  
Impact Resistant [Vandal Resistant]

**EPA - 1.00**

**Weight - 22 lbs**

**POLE NOT INCLUDED**



### Construction

**Aluminum**  
Less than 0.1% copper content – Marine Grade 6060 extruded & LM6 Aluminum High Pressure die casting provides excellent mechanical strength, clean detailed product lines and excellent heat dissipation.

**Pre paint**  
8 step decrease and phosphate process that includes deoxidizing and etching as well as a zinc and nickel phosphate process before product painting.

**Memory Retentive -Silicon Gasket**  
Provided with special injection molded "fit for purpose" long life high temperature memory retentive silicon gaskets. Maintains the gaskets exact profile and seal over years of use and compression.

**Thermal management**  
LM6 Aluminum is used for its excellent mechanical strength and thermal dissipation properties in low and high ambient temperatures. The superior thermal heat sink design by Ligman used in conjunction with the driver, controls thermals below critical temperature range to ensure maximum luminous flux output, as well as providing long LED service life and ensuring less than 10% lumen depreciation at 50,000 hours.

**Surge Suppression**  
Standard 10kv surge suppressor provided with all fixtures.

**BUG Rating**  
B2 - U0 - G2

**Finishing**  
All Ligman products go through an extensive finishing process that includes fettling to improve paint adherence.

**Paint**  
UV Stabilized 4.9Mil thick powder coat paint and baked at 200 Deg C. This process ensures that Ligman products can withstand harsh environments. Rated for use in natatoriums.

**Inspired by Nature Finishes**  
The Inspired by nature Finishing is a unique system of decorative powder coating. Our metal decoration process can easily transform the appearance of metal or aluminum product into a wood grain finish.

This patented technology enables the simulation of wood grain, and even marble or granite finish through the use of decorative powder coating.

The wood grain finish is so realistic that it's almost indistinguishable from real wood, even from a close visual inspection. The system of coating permeates the entire thickness of the coat and as a result, the coating cannot be removed by normal rubbing, chipping, or scratching.

**The Coating Process**  
After pre-treatment the prepared parts are powder coated with a specially formulated polyurethane powder. This powder provides protection against wear, abrasion, impact and corrosion and acts as the relief base color for the finalized metal decoration.

The component is then wrapped with a sheet of non-porous film with the selected decoration pattern printed on it using special high temperature inks.

This printed film transfer is vacuum-sealed to the surface for a complete thermo print and then transferred into a customized oven. The oven transforms the ink into different forms within the paint layer before it becomes solid. Finally, the film is removed, and a vivid timber look on aluminum remains.

Wood grain coating can create beautiful wood-looking products of any sort. There are over 300 combinations of designs currently in use. Wood grains can be made with different colors, designs, etc.

Our powder coatings are certified for indoor and outdoor applications and are backed by a comprehensive warranty. These coatings rise to the highest conceivable standard of performance excellence and design innovation.

- Added Benefits**
- Resistance to salt-acid room, accelerated aging
  - Boiling water, lime and condensed water resistant
  - Anti-Graffiti, Anti-Slip, Anti-Microbial, Anti-Scratch
  - Super durable (UV resistant)
  - TGIC free (non-toxic)

**Hardware**  
Provided Hardware is Marine grade 316 Stainless steel.

**Anti-Seize Screw Holes**  
Tapped holes are infused with a special anti seize compound designed to prevent seizure of threaded connections, due to electrolysis from heat, corrosive atmospheres and moisture.

**Crystal Clear Low Iron Glass Lens**  
Provided with tempered, impact resistant crystal clear low iron glass ensuring no green glass tinge.

**Optics & LED**  
Precise optic design provides exceptional light control and precise distribution of light.  
LED CRI > 80

**Lumen - Maintenance Life**  
L80 /B10 at 50,000 hours (This means that at least 90% of the LED still achieve 80% of their original flux)

**Modern, contemporary post top**  
**Beautiful modern urban post top in either single or V-arm configuration, offering powerful street lighting and asymmetric beam performance choices.**

A modern style die-cast aluminum post top decorative lantern with excellent downward light distribution that complies with dark sky requirements. Outstanding visual appeal and precision optical system gives very low glare rating, whilst reducing light pollution. This luminaire is available in two configurations, namely a single or v-arm option to suit aesthetic design requirements.

Color temperature 2700K, 3000K, 3500K and 4000K, LED CRI >80 and life time 50,000 Hours. Stainless steel screws. Durable silicone rubber gasket and clear tempered glass. Powder paint with high corrosion resistance with chemical chromatised protection. Integral control gear.

Customer specific wattages can be provided, please contact the factory for more information.

Available with a selection of dimmable integral electronic drivers, as well as a provision to install wireless lighting controls to integrate with building management systems. (WATT-ADJ) This luminaire is provided with a programmable driver so that specific wattage requirements can be achieved. These settings are done at the factory during assembly.

To meet International Dark Sky criteria, 3000k or warmer LEDs must be selected.

### Additional Options (Consult Factory For Pricing)



A90991  
Zhaga Book 18



A90891  
NEMA 7



RGBW  
RGBW Macaron



### LIGHCONNECT IoT Ready Macaron

**This luminaire is available with NEMA 7 or Zhaga Book 18 sockets for connection to intelligent lighting control systems.**

### SPLIT BEAM OPTIONS

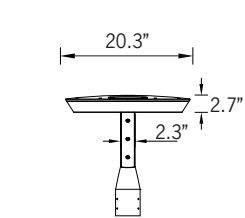
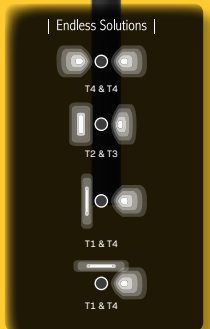

Fixture Detail

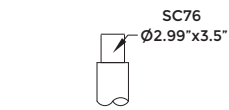

Tenon Detail

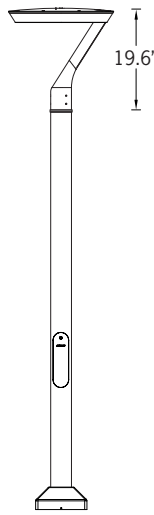

Ligman's micro Variable Optical System provides the ability to interchange, mix & rotate optics to provide specific light distributions for optimized spacing and uniformity.

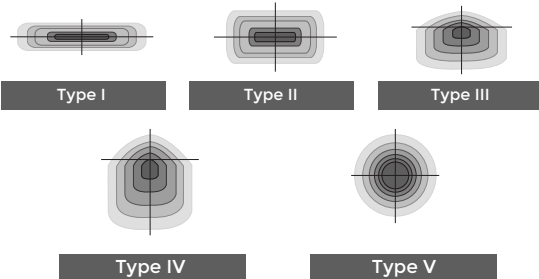

The variable optic system allows for the designer to create hybrid distributions for precise lighting requirements.

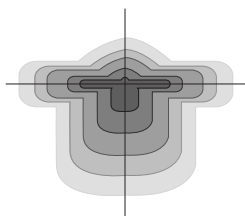

HYBRID  
TYPE I & TYPE IV

# UMC-20002

## Macaron 1 Post Top

<b>PROJECT</b>	<input type="text"/>	<b>DATE</b>	<input type="text"/>
----------------	----------------------	-------------	----------------------

<b>QUANTITY</b>	<input type="text"/>	<b>TYPE</b>	<input type="text"/>	<b>NOTE</b>	<input type="text"/>
-----------------	----------------------	-------------	----------------------	-------------	----------------------

ORDERING EXAMPLE || UMC - 20002 - 104w - T2 - W30 - 02 - 120/277v - Options

<b>UMC-20002</b>	<input type="text"/>	<input type="text"/>	<input type="text"/>	<input type="text"/>	<input type="text"/>
	<b>LAMP</b>	<b>BEAM</b>	<b>LED COLOR</b>	<b>FINISH COLOR</b>	<b>VOLTAGE</b>

104w LED  
14374 Lumens

- T1 - Type I Distribution
  - T2 - Type II Distribution
  - T3 - Type III Distribution
  - T4 - Type IV Distribution
  - T5 - Type V Distribution
  - ME - Type ME Distribution
- FOR SPLIT BEAM, SPECIFY BELOW

- W27 - 2700K
- W30 - 3000K
- W35 - 3500K
- W40 - 4000K

- 01 - BLACK RAL 9011
- 02 - DARK GREY RAL 7043
- 03 - WHITE RAL 9003
- 04 - METALLIC SILVER RAL 9006
- 05 - MATTE SILVER RAL 9006
- 06 - LIGMAN BRONZE
- 07 - CUSTOM RAL

- 120/277v
- Other - Specify

<input type="text"/>	<input type="text"/>
<b>SPLIT BEAM LEFT</b>	<b>SPLIT BEAM RIGHT</b>

- T1 - Type I Distribution
- T2 - Type II Distribution
- T3 - Type III Distribution
- T4 - Type IV Distribution
- T5 - Type V Distribution
- ME - Type ME Distribution

- T1 - Type I Distribution
- T2 - Type II Distribution
- T3 - Type III Distribution
- T4 - Type IV Distribution
- T5 - Type V Distribution
- ME - Type ME Distribution

**INSPIRED BY NATURE FINISHES**

- SW01 - OAK FINISH
- SW02 - WALNUT FINISH
- SW03 - PINE FINISH
- DF - DOUGLAS FIR FINISH
- CW - CHERRY WOOD FINISH
- NW - NATIONAL WALNUT FINISH
- SU01 - CONCRETE FINISH
- SU02 - SOFTSCAPE FINISH
- SU03 - STONE FINISH
- SU04 - CORTEN FINISH

THERE IS AN ADDITIONAL COST FOR THESE FINISHES

<input type="text"/>	<input type="text"/>	<input type="text"/>
----------------------	----------------------	----------------------

**ADDITIONAL OPTIONS**

- DIM - 0-10v Dimming
- NAT - Natatorium Rated
- A20491 - Root Mount Kit
- A90891 - NEMA 7
- BS - Bird Spikes
- RCBW - RCBW Macaron
- OS - FSP Occupancy Sensor [See last page]
- FSIR - Occupancy Sensor Remote Programmer [See last page]
- A90991-U - Zhaga Book 18 Mounted On Top of Fixture
- A90991-D - Zhaga Book 18 Mounted Below Fixture
- AMB - Turtle Friendly Amber LED
- IHSS - Internal House Side Shield

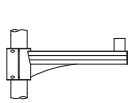

A20176  
Aluminum Arm Pole Clamp

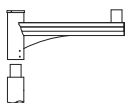

A20276  
Aluminum Single Arm

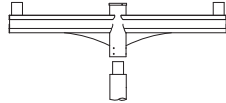

A20376  
Aluminum Double Arm



BS  
Bird Spikes

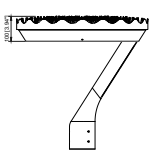

IHSS  
Internal House Side Shield

**More Custom Finishes Available Upon Request**  
Consult factory for pricing and lead times

- |          |            |
|----------|------------|
|          |            |
| Oak      | Beech      |
|          |            |
| Walnut   | Bamboo     |
|          |            |
| Pine     | Birch      |
|          |            |
| Cherry   | Carbon     |
|          |            |
| Chestnut | Galvanized |
|          |            |
| Mahogany | Steel      |



Example: Inspired by Nature Finish

# Macaron Product Family



Macaron 1

- UMC-20001-81w-7263lm
- UMC-20002-104w-14374lm



Macaron 2

- UMC-20011-81w-7263lm
- UMC-20012-104w-14374lm



Macaron 3

- UMC-98001-104w-14374lm



Macaron 4

- UMC-10001-22w-2854lm [23.6°]
- UMC-10002-31w-3904lm [23.6°]
- UMC-10003-46w-5021lm [23.6°]



Macaron 5

- UMC-10011-22w-2854lm [39.3°]
- UMC-10012-31w-3904lm [39.3°]
- UMC-10013-46w-5021lm [39.3°]



Macaron 8

- UMC-20041-22w-2854lm

## CITY OF FLAGSTAFF & TURTLE FRIENDLY COMPLIANT

AMB Spectral Diagram

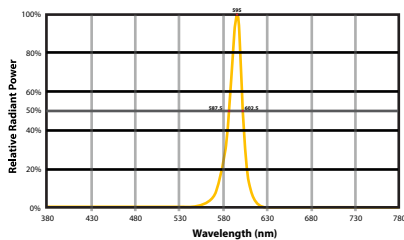

### Narrow-Spectrum Amber LEDs

Peak wavelength between 585 & 595 nanometers and a full width of 50% power no greater than 15 nanometers.

# HIGH/LOW/OFF PIR OUTDOOR PHOTO/MOTION SENSOR IP66 - Integrated photocell

Ligman provides integrated photocell control using the wattstopper legrand FSP-211B. These units are installed inside the fixture housing with only the external lenses being visible



FSP-211B

## Dimensions of Lens Options

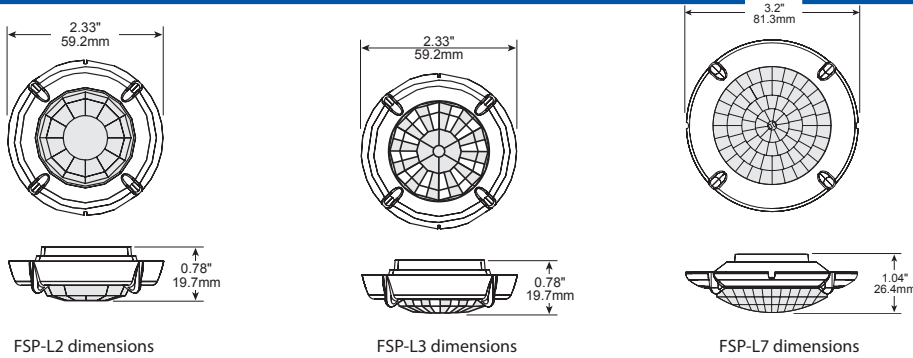

## Product Overview

The FSP-221B is a family of passive infrared (PIR) outdoor sensors that raise or lower the electric lighting level to high, low or off based on motion and/or daylight contribution. Typically, once the sensor stops detecting movement and the time delay elapses, lights will first fade to low mode, and eventually switch off. When motion is detected, the sensor ramps the light level to high mode unless the daylight contribution is sufficient.

The integral photocell can also switch the lights on and off for dusk to dawn control, so that lighting remains on overnight even without motion detection.

The sensors control 0-10VDC or nondimming LED drivers or ballasts.

The low voltage FSP-201B may be used with dim-to-off drivers or ballasts.

Initial setup and subsequent sensor adjustments are made using a Wireless Handheld Configuration Tool (FSIR-100). This tool enables adjustment of sensor parameters including high/low mode, sensitivity, time delay, cut off and more.

The FSIR-100 can read current parameter settings, and stores up to six sensor parameter profiles to speed commissioning of multiple sensors.

## Models

- FSP-211B, 120-277 VAC
- FSP-221B, 100-347 VAC

## Specifications and Features

- Three interchangeable lenses for mounting between 8' and 40'
- Remote setup and adjustment with handheld wireless configuration tool
- Adjustable high and low modes (high: 0 to 10V, low: off, 0 to 9.8V)
- Adjustable time delay (30 seconds, 1 to 30 minutes)
- Adjustable cut off delay (none, 1 to 59 minutes, 1 to 5 hours)
- Adjustable sensitivity/service mode (low, med, max; on-fix, off-fix)
- Adjustable setpoints: hold off setpoint (none, 1 to 250 fc, auto); photocell on/off setpoint (1 to 250 fc)
- Adjustable ramp and fade times (1 to 60 seconds)
- Operating temperature: -40°F to +167°F (-40°C to +75°C)
- IP66 rated
- Five year warranty



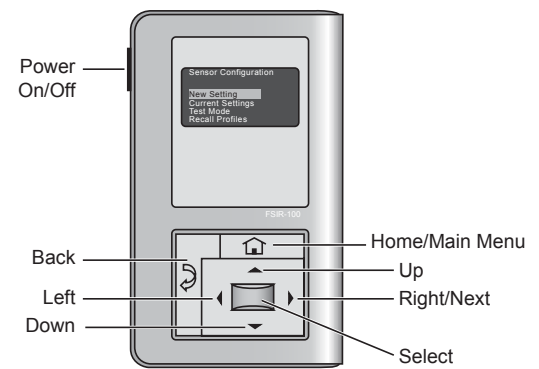
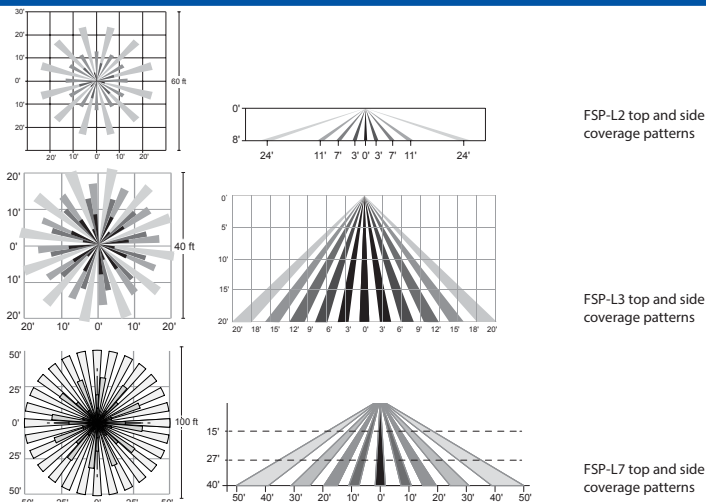

## Factory Defaults

High mode:	10V
Low mode:	1V
Time delay:	5 minutes
Cut off:	1 hour
Setpoint:	Disabled
Sensitivity:	Max
Ramp up time:	Disabled
Fade down time:	Disabled
Photocell On/Off:	Disabled

## Coverage



The FSIR-100 is a convenient handheld remote tool for sensor setting. Adjustable settings can be changed as needed for specific applications.

Catalog #	Color	Description
 FSP-L2	White/Grey/Black/Brown <small>The Trim color option will be selected to closest match fixture color. e.g. (Matte silver fixture - grey trim)</small>	360° lens, maximum coverage 48' diameter from 8' height
 FSP-L3	White/Grey/Black/Brown <small>The Trim color option will be selected to closest match fixture color. e.g. (Matte silver fixture - grey trim)</small>	360° lens, maximum coverage 40' diameter from 20' height
 FSP-L7	White/Grey/Black/Brown <small>The Trim color option will be selected to closest match fixture color. e.g. (Matte silver fixture - grey trim)</small>	360° lens, maximum coverage 100' diameter from 40' height
 FSIR-100	Black	Remote Handheld Configuration Tool